



## **OPERATING MANUAL**

**for the modular heat press**

**Secabo TS7 SMART**

Congratulations on the purchase of your Secabo heat press!

Please read this operating manual carefully to ensure a smooth production launch with your new device.

Any type of reproduction of this operating manual requires the written permission of Secabo GmbH. Modifications to and errors in the technical data and/or product characteristics are reserved.

Secabo GmbH accepts no liability for any direct or indirect damages resulting from the use of this product.

*Version 1 (02.06.2020)*



## Safety Precautions

Please read the information and safety precautions carefully prior to first commissioning of the device!

- Never reach inside the heat press with your hands when it is connected to the power supply, especially if it is switched on and heated up – danger of burns!
- Never open the casing and do not make any modifications to the unit yourself.
- Should it be necessary to open the heat plate cover upon explicit request by Secabo's customer service team, it is recommended you wear respiratory protection and only touch the insulation wool located therein using gloves. Possible disposal of the insulation wool should only be done inside a closed bag.
- Ensure that neither liquids nor metal objects reach the inside of the heat press.
- Make sure you use a grounded wall socket. Keep in mind that a heat press may only be operated using a wall socket equipped with a ground fault circuit interrupter.
- Disconnect the heat press from the power supply when it's not in use.
- Always ensure that the heat press is out of reach of children during operation and never leave the device unsupervised when switched on.
- Make sure the unit is only used in dry rooms.

**If you cannot comply with one or more of the aforementioned safety rules, or if you are unsure as to whether you're in compliance with all of the points, please contact our technical support.**

## Items included

Mechanical base of the heat press

**heat press base**

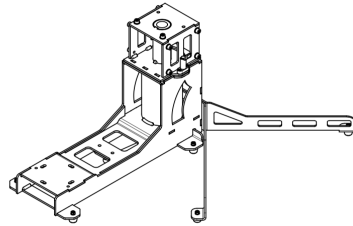

Mechanical head of the heat press

**heat press head**

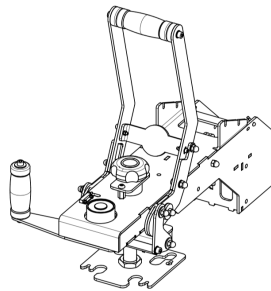

**Heat plate and base plate**  
**HP7 - 40cm x 50cm**

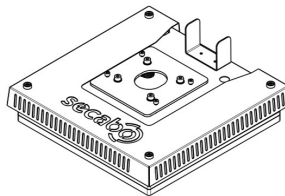

Controller Box  
**HPC01**

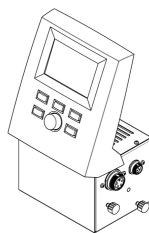

C13 Cold device cable

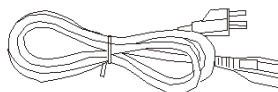

Size 5 Allen key for M6 inner hexagonal screws



Spanner 13 for M8 hexagon screws

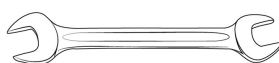

## Machine description

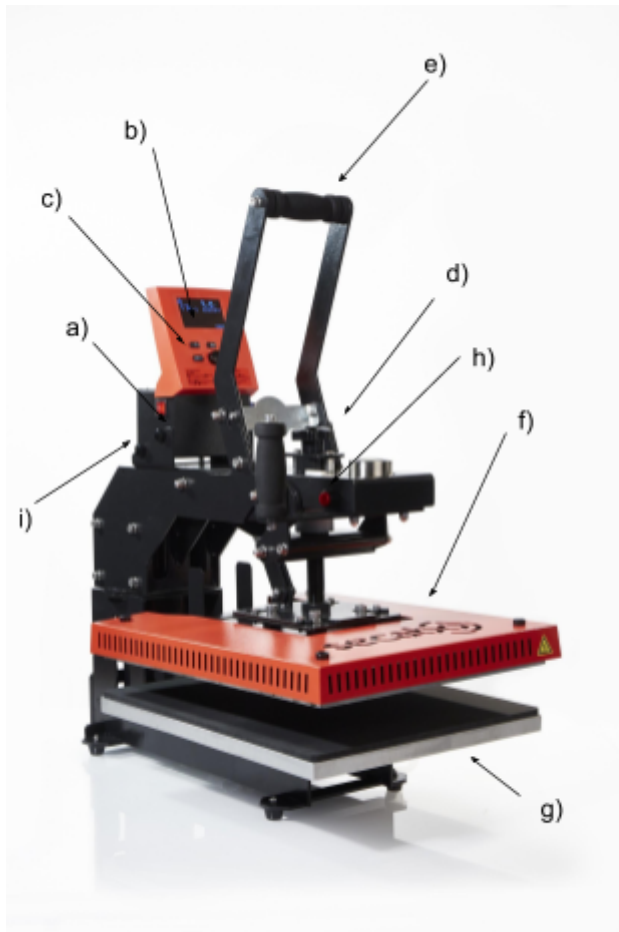

- a. Main switch
- b. Liquid Crystal Display (LCD)
- c. Control panel with buttons and rotary push setter
- d. Hand wheel for pressure adjustment
- e. Press lever
- f. Heat plate cover and heat plate
- g. Base plate
- h. Button for manually opening the press
- i. IEC socket and internal connections (not depicted)

## Installation and Commissioning

- Safely set up the base frame **heat press base** of the TS7 Smart heat press on a sturdy table.

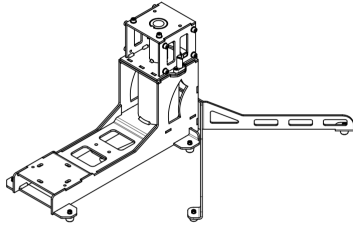

- Remove the 10 Screws of the **heat press base**

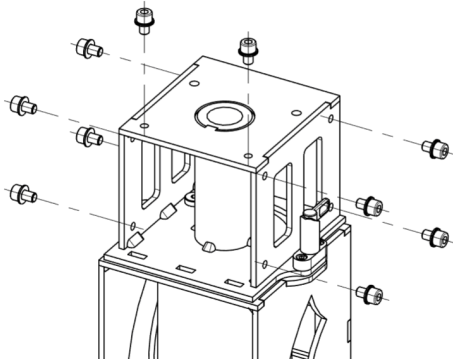

- Connect the **heat press base** with the **heat press head**.

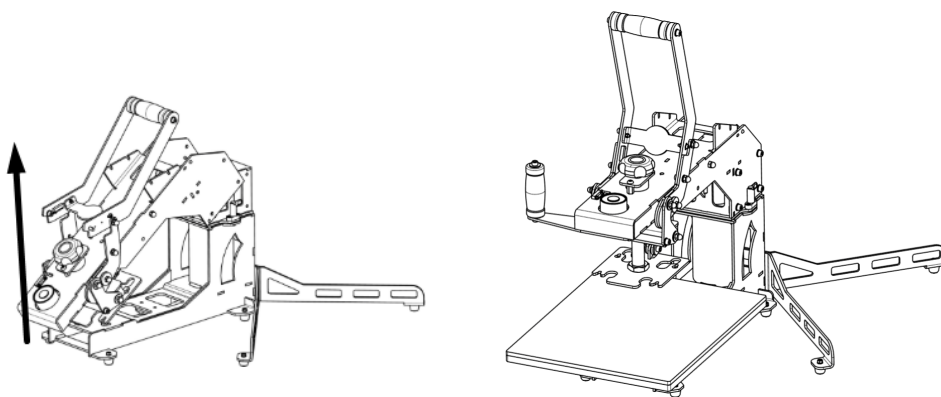

- Fix again the 10 screws which were removed before again.

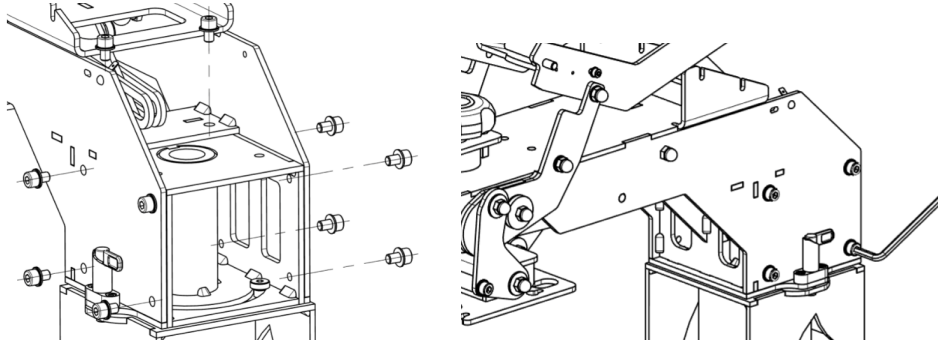

- Remove the screws from the lever

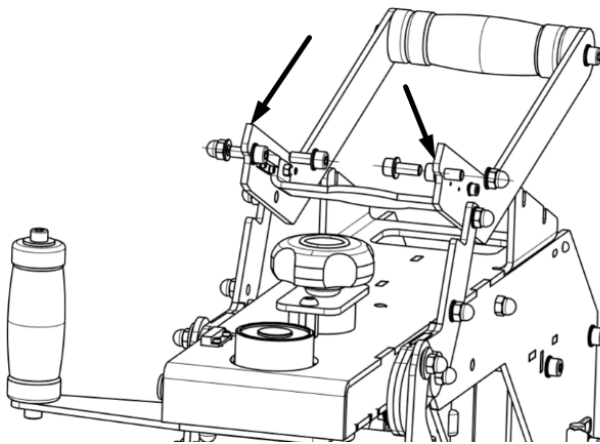

- Move the lever to the front and fix it again.

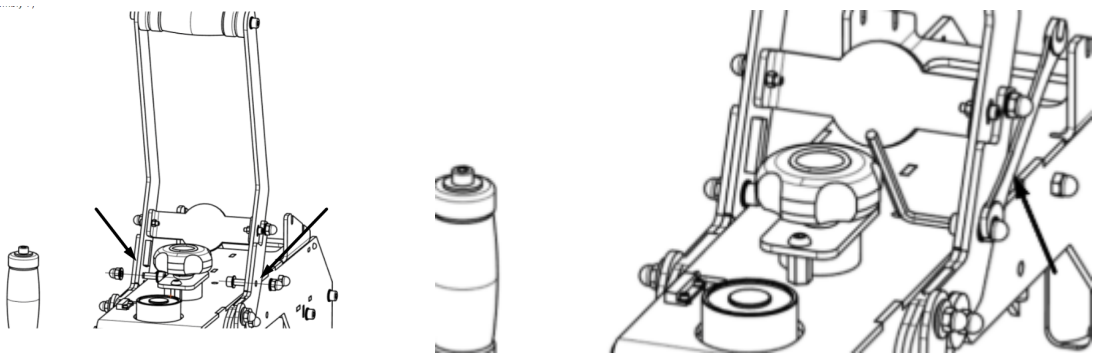

- Connect the base plate with the heat press base (only the adapter is visible) and fix it in advance.

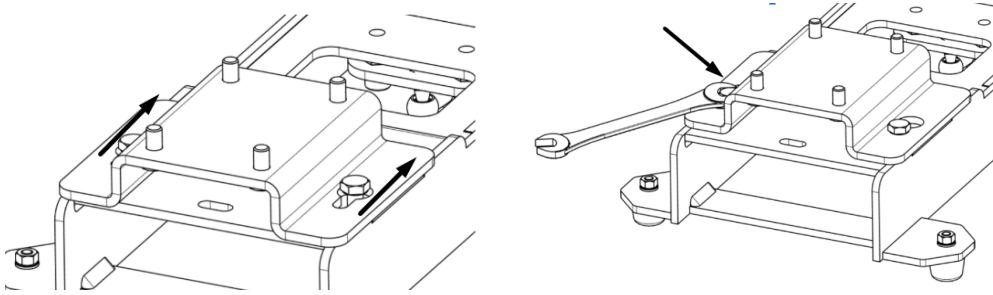

- Position the heat plate **HP7** in front of the connecting flange below the press lever on the **heat press base** at a slant and thread the 4 outer screws heads into the keyhole grooves on the flange plate.

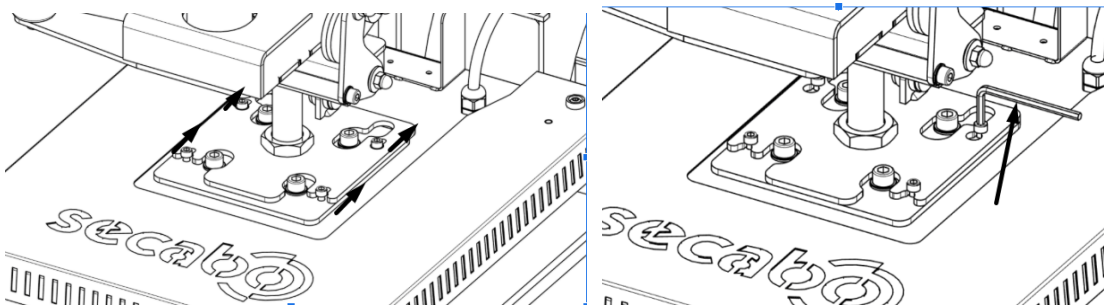

- Carefully tighten the screws with the supplied allen wrench. **Attention, the heating plate can fall down as long as the screws are not tightened! Risk of injury!**

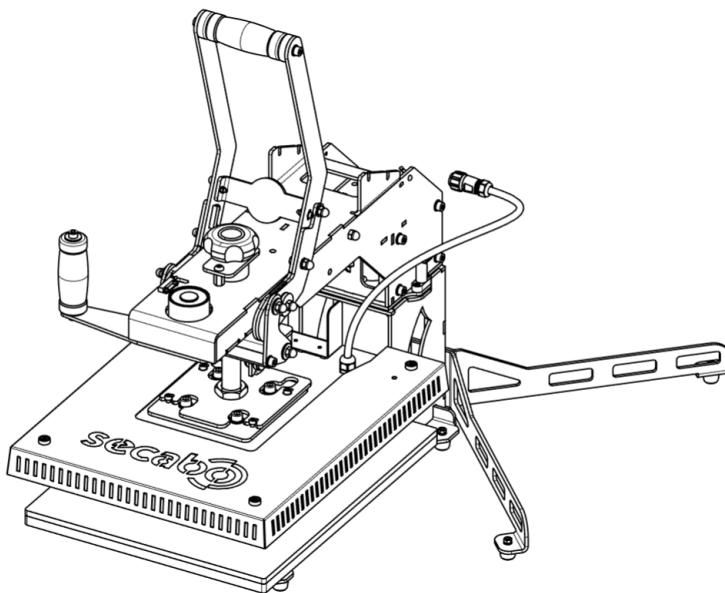

- The basic frame is completely assembled.

- Position the controller box at the upper rear center of the base frame of the TS7 SMART heat press and let the studs at the controller box slide into the slots on the **heat press base**. Securely tighten the hand nuts.

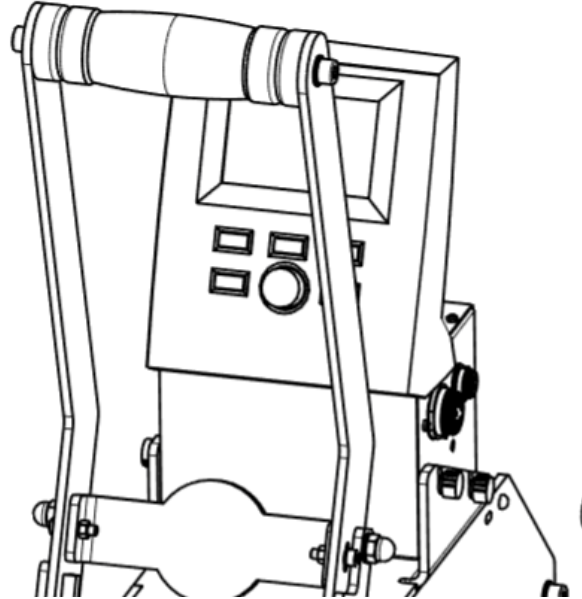
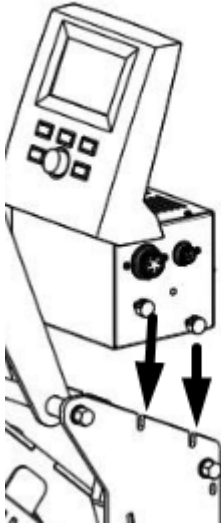

- Attach the small 6-pin plug from the rear side of the **heat press base** to the appropriate socket on the outer right side of the controller box **HPC01**.
- Attach the large 5-pin plug from the surface of the **heat plate** to the appropriate socket on the right outer side of the controller box **HPC01**.

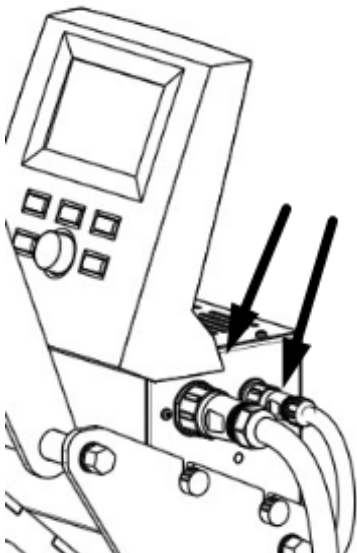





- Connect the protective earth cable from the HPC01 controller to the rear of the terminal provided on the heat press base.
- Plug the supplied C13 power cable into the rear of the HPC01 controller box and connect it to a grounded outlet, which must have a grounded connection and be protected by a fuse and a ground fault circuit interrupter.

**The TS7 SMART heat press is now ready for use.**

## Controller components and operation

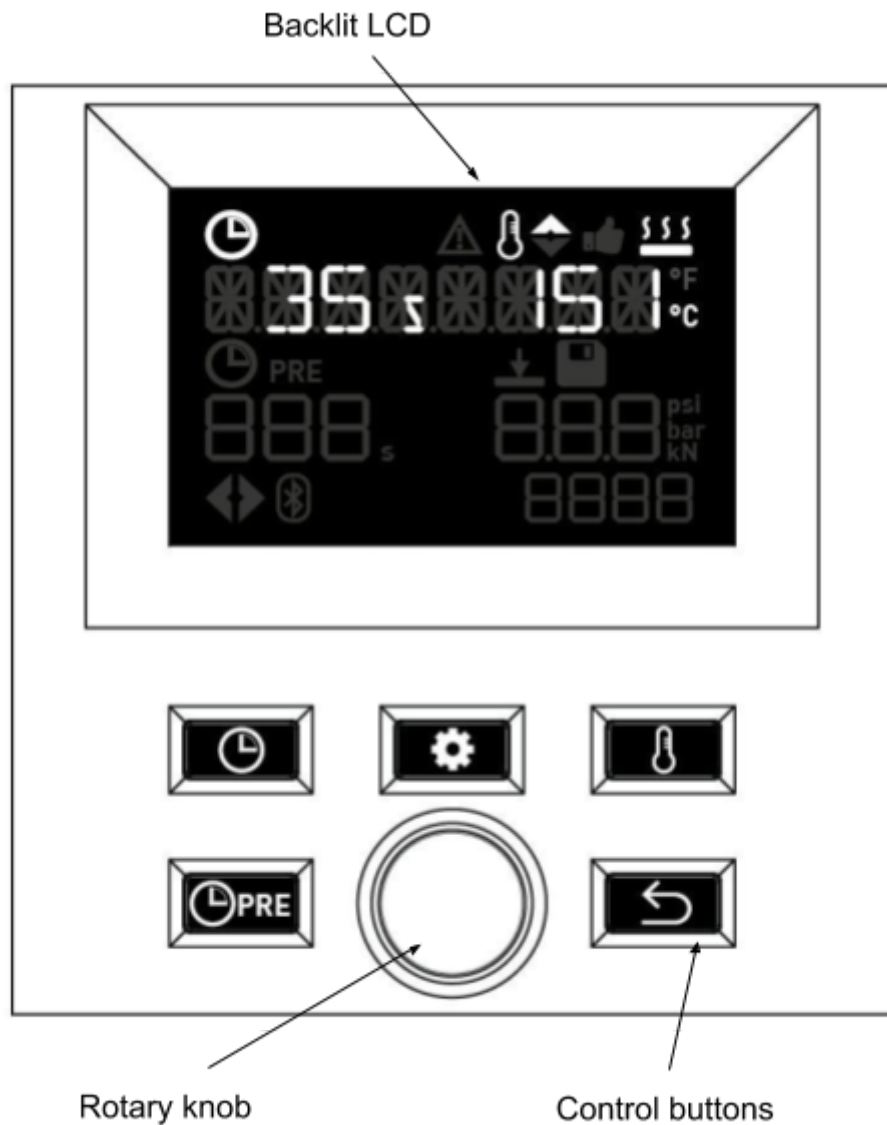

## Display components and their meaning

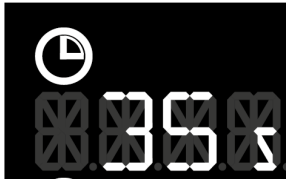

Area for time setting and countdown when press is closed



Area for time setting and activity indicator of the pre-press feature



Icon for the Bluetooth connection



General indicator for fault or error

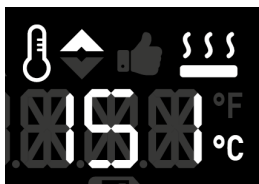

Area for temperature indicator for target temperature and actual temperature



Indicator: Heat plate's heating active



Indicator: Press is done heating up



Indicator: Press is currently heating up or cooling down. If below the set temperature, up arrow will flash.





Indicator for management of memory slots



Counter for counting the performed press operations

## How to use the controller

### Setting the temperature:

Briefly press , the symbol in the display starts flashing. The value in the display changes from the current ACTUAL value to the TARGET value, which can now be set. Turn clockwise to increase the TARGET temperature, counterclockwise to decrease. Press the rotary knob or press  to store the set value. If no input occurs for 5 seconds, input mode ends automatically. Pressing  exits input mode, the set value is not applied and the display returns to the current ACTUAL value.

### Temperature-related indicators:



is activated whenever the heater is running.

During the warm-up phase, every 10s an estimated remaining warm-up time scrolls across the display for 3s instead of the current temperature.



is activated when the CURRENT temperature corresponds with the TARGET temperature, allowing for a certain deviation of X°.



Arrow up is activated when the temperature is rising (if below TARGET temperature, arrow is blinking), arrow down is activated when the temperature is dropping, e.g. during a transfer or if the heat plate is still hotter than the set target temperature.



is generally activated in the event of faults or errors, and when there is a significant deviation between TARGET and CURRENT temperature (value outside of a range that allows for pressing).

### Setting the time:



push briefly, symbol in the display flashes. Turning the rotary knob clockwise

increases time, counter-clockwise decreases. Press the rotary knob or press  to



store value. If no input occurs for 5 seconds, input mode ends automatically. Pressing



will exit the input mode, the display will return to its original value.

## Configuring pre-pressing:

Briefly pressing  activates pre-pressing for the following press operation using the preset time, and is deactivated again upon completing the press operation. When activated, the Time+Pre symbol will light up in the lower part of the display with the corresponding time indicator. This will count down to 0 while pressing, whereupon the symbol and time switched off again.

Holding  activates the setting mode for the PRE time analog with time setting: Symbol in the display flashes. Turning the rotary knob clockwise increases time, counter-clockwise decreases. Press the rotary knob or press  to store value. If no input occurs for 10s, input mode ends automatically. Pressing  will exit the input mode, the display will return to its original value.

Pre-pressing can be activated permanently from the settings menu. More information below.

## Saving to and loading from memory slots:

Press and hold rotary knob in the default state.  flashes. The number corresponding with the memory slot is shown below the disk. This indicator rises by one when turning the rotary knob clockwise. Each stored temperature value and time / PRE time value is also displayed at the top. If memory slot is blank, dashes are displayed for temperature and time / PRE time.

To retrieve a stored value, confirm the selected value in the display by briefly pressing the rotary knob. The stored values are now displayed,  is deactivated and no longer flashes.

To save the current values (to blank or currently used memory slots), first push and hold

the rotary knob ( flashes), then select the desired memory slot, then hold the knob until the values and symbols flash briefly. The values are now both, saved and loaded,



no longer flashes, the memory mode has been exited.

## Setting tier:



You generally navigate through the setting tiers according to the following scheme:

- Rotate knob - scroll through the settings.
- Press knob - dive into current setting.
- Rotate knob - choose values within the setting.
- Press knob - store value and exit from the setting.
- You may press  to return to the parent tier if no action is to be taken in the subordinate tier.

The following eight menu items are available in the setting tier.

1. Auto Prepress
  - Enable / Disable a permanent pre-pressing.
2. Bluetooth
  - Enable / Disable Bluetooth.
3. Bluetooth PIN
  - You can use the rotary knob to save your individual PIN, which the app will then prompt you to enter. The default PIN from factory is 255, which is automatically recognized and used by the app.
4. Warning signal
  - Enable / Disable the warning signal before opening the press.
5. Sleep Mode
  - Setting the time interval in minutes, after which the press enters the Sleep Mode.

- In addition, the temperature the press should be cooled down to when in Sleep Mode can also be set.
  - To completely disable Sleep Mode, set the time value to "0".
  - The active Sleep Mode can be exited at any time by pressing any button or by actuating the press lever. The press will then restore the previously set parameters.
6. Auto Off
- Setting the time interval in minutes, after which the press completely turns off the heating.
  - To completely disable Auto Off Mode, set the time value to "0".
  - The active Auto Off Mode can be exited at any time by pressing any button or by actuating the press lever. The press will then restore the previously set parameters.
7. Language
- Setting the menu language.
8. Unit
- Configuring the temperature unit. Celsius or Fahrenheit are possible.

## Resetting the counter:



Press the  button for 2s, display flashes briefly, values are set to 0.

## Pair heat press with mobile device



- Press the  key on the controller

- **Enable Bluetooth:**

Use the wheel to scroll to the Bluetooth ON/OFF setting and press the wheel once. Now turn the wheel again to set Bluetooth to ON and confirm again by pressing the wheel.

- **Setting the Bluetooth PIN:**

Use the wheel to scroll to the Bluetooth PIN setting and press the wheel once. Now turn the wheel again to set the desired Bluetooth PIN and confirm again by pressing the wheel. The default PIN is 255.

- Press the Settings button on the controller to exit the Settings menu

- Download the Secabo Smart Transfer App to your mobile phone and start it.
- The first time you start the app, you will receive a brief introduction that will help you understand the features and benefits of the app.



- After the introduction, a dialog opens, which will assist you with connecting the press to the app. The app automatically searches for Secabo Smart heat presses in the area. Please make sure that Bluetooth is activated on your smartphone.
- Simply select the respective heat press from the list to connect to it. If you have changed the Bluetooth PIN on the heat press, the app will prompt you to enter it in the app.
- The heat press is now connected and ready for use.

### Controlling the heat press via Secabo Smart Transfers app

To learn how to control your Secabo TC SMART Transfer Press via the Secabo Smart Transfer App, please refer to the app introduction as well as the help pages within the app.

### Second setting tier for operational key figures and service

Press and hold the Settings button  to enter the second tier of the settings. Here you can retrieve helpful data and counter readings by turning the rotary knob.

1	Service Tag
2	Firmware version
3	Serial number of the controller
4	Long-term counter press operations
5	Operating hours counter in hours





## Operation of the heat press

### Performing transfers

- Turn on the heat press via the main switch.
- The press will now heat up to the set temperature.
- Please refer to previous chapters to learn how to change the settings on the controller.
- Once the press has heated up, you can proceed with the first transfer. The clock starts counting as soon as the press is closed with the press lever.
- 3 seconds before the set time elapses, a warning signal is sounded (if activated in the settings), then the press opens automatically.
- You can adjust the contact pressure by turning the large hand screw at the top of the press to increase or decrease the distance the lever travels. Turning the knob clockwise increases the pressure, while turning it counterclockwise decreases it.
- No settings can be changed during the press operation.
- With each completed press operation, the value indicated by the counter increases by one, as soon as the specified time has fully elapsed.

**Note: Please keep in mind that it takes some time for the press to cool off after it is switched off.**

## Maintenance and cleaning

All maintenance work must be carried out with the press switched off and cooled off, no exceptions! First, remove the plug from the wall socket. Only perform maintenance work after consultation with our technical support team.

The press should be cleaned regularly using a soft cloth and a mild household cleaner to remove adhesive residues, dust, etc. Do not use scouring sponges, solvents or gasoline!

## Recommended times and temperatures

These values should only be considered as guideline values, may vary depending on the material and must be checked before pressing.

Material	Temperature	Pressure	Press duration
<b>Flock film</b>	170°C - 185°C 338°F - 365°F	low-medium	25s
<b>Flex film</b>	160°C - 170°C 320°F - 338°F	medium-high	25s
<b>Sublimation flex</b>	180°C - 195°C 356°F - 383°F	medium-high	10s - 35s
<b>Sublimation on mugs</b>	200°C 392°F	medium-high	150s - 180s
<b>Sublimation on tiles</b>	200°C 392°F	high	120s - 480s <small>(depends on the thickness of the material)</small>
<b>Sublimation on puzzles</b>	200°C 392°F	low-medium	25s
<b>Sublimation on mouse pads</b>	200°C 392°F	medium	20s - 40s
<b>Sublimation on garments</b>	200°C 392°F	medium-high	30s - 50s
<b>Sublimation on metal plates</b>	200°C 392°F	high	10s - 50s <small>(depends on the thickness of the material)</small>

**Important note: You should perform your own tests with the respective transfer materials and carrier media prior to each production. The aforementioned values, as well as any manufacturer specification merely serve as indications. Washing resistance and behavior during the transfer must be determined by performing your own tests.**

**No guarantee can be derived from the recommended values. It is always the user's responsibility to determine and apply the correct settings for his specific conditions.**

**Note on garment finishing processes: After the press operation, garments must cool off**



before any carrier media can be pulled off the transfer material. The hot glue in the transfer material doesn't develop its adhesive strength until cooled off. If the glue does not stick in its cold state, this may indicate that the pressing procedure was too cold or too short.

## Technical data

<b>Heat press</b>	<b>Secabo TS7 SMART</b>
<b>Type</b>	auto opening swing away heat press
<b>Working area size</b>	40cm x 50cm
<b>Swing angle:</b>	110 °
<b>Max. temperature</b>	225 °C
<b>Max. preset time</b>	999s
<b>Max. working pressure</b>	250 g/cm <sup>2</sup>
<b>Pressure setting</b>	Height-adjustment of the heat plate via hand wheel
<b>Power supply</b>	AC Voltage 230V / 50Hz - 60Hz, 2 kW
<b>Environment</b>	+ 5°C - +35°C / 30% - 70% relative humidity
<b>Weight</b>	64kg
<b>Weight with packaging</b>	75kg
<b>Closed dimensions (W x H x D)</b>	B: 596 mm x T:1070 mm H:854 mm
<b>Open dimensions (W x H x D)</b>	B: 920 mm x T:1070 mm H:854 mm

## Konformitätserklärung - Statement of Conformity

Hiermit erklären wir in alleiniger Verantwortung, dass das unter „Technische Daten“ genannte Produkt mit den Bestimmungen der folgenden EG-Richtlinien und Normen übereinstimmt:

We herewith declare under sole responsibility that the under „technical data“ mentioned product meet the provisions of the following EC Directives and Harmonized Standards:



EG-Richtlinien / EC directives:

2014/35/EG Niederspannungsrichtlinie /

2014/35/EC Low Voltage Directive

98/37/EG Maschinenrichtlinie (2006/42/EG vom 12/29/2009) /

98/37/EC Directive on machinery (from 2009-12-29: 2006/42/EC)

Norm / Standard: EN 60204-1:2006

Technische Dokumente bei / Technical documents at:

Secabo GmbH, Hochstatt 6-8, 85283 Wolnzach, Germany

A handwritten signature in black ink, appearing to read 'Fabian Franke'.

Dipl. Ing. Fabian Franke

A handwritten signature in black ink, appearing to read 'Bernhard Schmidt'.

Dipl. Ing.(FH) Bernhard Schmidt